

PREAMBLE

This Technical User Guide contains warnings and guidance for correct and safe operation of the product. These instructions must be followed at all times. TPL Vision will not be held responsible for problems caused by using the product contrary to these instructions and the Warranty will be deemed invalid.



UNPACKING

This product is packed at the factory using suitable materials for safe transport. To open the package, do not use any cutting blade to avoid damaging the product(s). Please use the delivered accessories if needed. (Do not use any other products or equivalents to replace the delivered accessories).

In the event of damage occurring during shipping, it must be reported to the carrier at time of delivery (including noting the damage in writing on the delivery documents). It is also your responsibility to notify TPL Vision in writing of the damage within 24 hours of receipt of the package. If these instructions are not followed, TPL Vision reserves the right not to accept requests for return and exchange of damaged products.

RISK CLASS

The applicable Standard EN-62471 classifies LED Lighting into 4 classes according to their degree of hazard severity. The table below summarises the risks associated with our standard products.

Colour	Class	Risk
–	0	none
White WHI (5700K), Red 630 nm, Green 525 nm, Blue 470 nm	1	low
IR 850 nm	2	moderate
UV 365 nm, UV 385 nm, UV 405 nm	3	high

TPL Vision can provide **guidance notes to minimise photo-biological risks**, including the nominal minimum operating distance. Please contact TPL Vision through your **usual representative** for this information.

In all cases, TPL Vision recommends the use of **the protection glasses** that are listed in its catalog.



Please be careful with the variable optics on this product. With the minimum beam angle (lens at maximum height) the light is extremely focused. This presents an eye safety issue, particularly with direct emissions from a short working distance.



ZOOM Z-SPOT TECHNICAL USER GUIDE

P2/8

DIMENSIONS

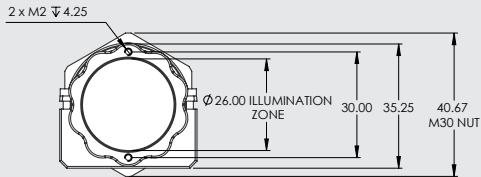

Z-SPOT	
Max length	104.9 mm
Min length	98.6 mm
Max width	40.67 mm

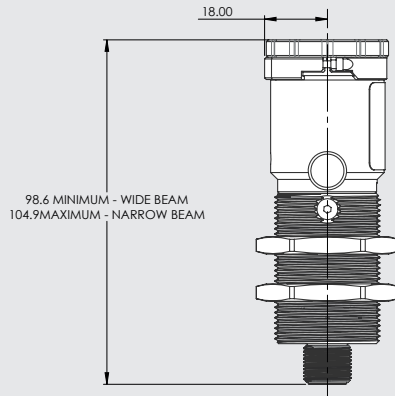
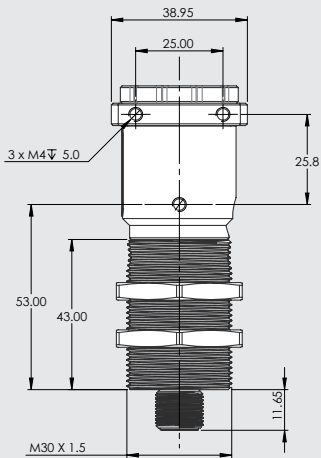

LED INDICATORS

The power supply is equipped with 2 LED indicators :

- **N°1**: indicates that the light is powered but the LEDs are not turned ON with this indicator alone.
- **N°2**: indicates that the LEDs are switched on.

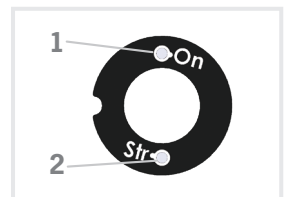



LOCKING RING FOR THE ADJUSTABLE ZOOM LENS

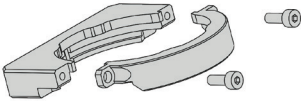

The Zoom lens of the Z-SPOT comes with a locking ring which enables the user to lock the lens position.

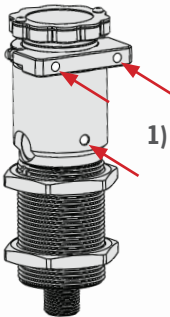

1) The Z-SPOT will have the locking ring attached when packaged. To ensure it is correctly orientated ensure that all three of the M4 fastening points are all on the same side.

2) The locking ring will be correctly aligned when the diagonal and straight line are in this orientation.

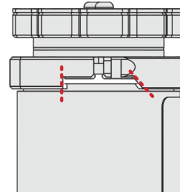

3) Tighten the locking ring screw with a 1.5mm Allen key.

FIXING: M30 X 1.5mm NUTS

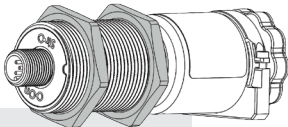

Please use the 2 supplied M30 x 1.5mm nuts to fix the product

As part of the setup process, it is imperative to ensure the light is switched off and unplugged for safety and proper installation.

MOUNTING POINTS

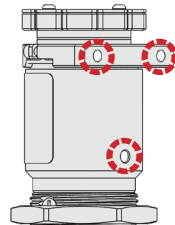

The Z-SPOT features three M4 mounting points spaced along its body, providing versatile options for securely attaching and mounting the product. For the 3rd M4 mounting point, a 1.8mm thick M4 washer is required to ensure proper installation and stability.



ZOOM Z-SPOT TECHNICAL USER GUIDE

CONNECTION

M12 Connector 5 male points

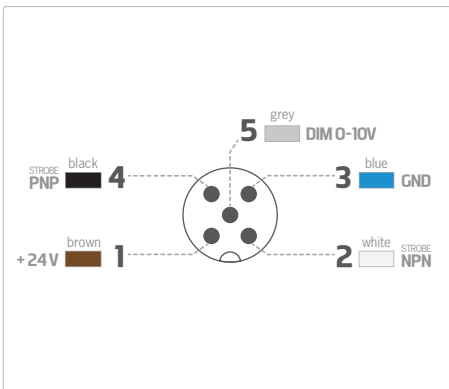

STROBE PNP :

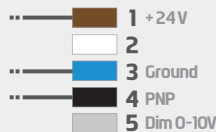

STROBE NPN :

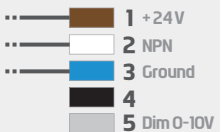

CONTINUOUS MODE :

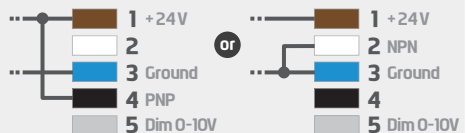

EMC IMMUNITY CONNECTIONS: for greater EMC immunity when using the light under Strobe operation, configure the signal connections as illustrated here. For Dimming, the Pin (5) should be connected to a voltage between 0V and 10V to ensure light output is correctly configured.



STROBE PNP :

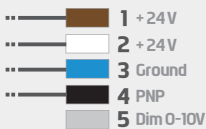

STROBE NPN :

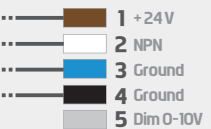

POWER SUPPLY

	Z-SPOT
Consumption CW mode	6W
Consumption Strobe mode*	13.2W
Min. functioning Voltage	20V in the light input
Normal functioning Voltage	24V in the light input (±10%)
Max. functioning Voltage	27V in the light input
Max. consumption Strobe and Dimming signal	10mA

* Strobed with 20% duty cycle – this is the peak consumption. You must use a power supply with this rating.



CONTROL

The product is optimised for a lifespan >50kh in a 40°C (104°F) atmosphere.
 In strobe mode, the strobing time is directly equivalent to the time during which the strobe entry is activated.

STROBE PNP & NPN:

- **PNP** : from 5 to 24V for 100% ON. From 0 to 2V for 100% OFF.
- **NPN** : less than 1V for 100% ON. Above 1.5V for 100% OFF. Max 20V.

Brightness	D max	t max	f max
30% to 100%	N/A	CW	N/A
100% to 300%	20%	10 ms	700Hz

CW : Continuous Working
 D : Duty Cycle
 t : pulse duration
 f : frequency

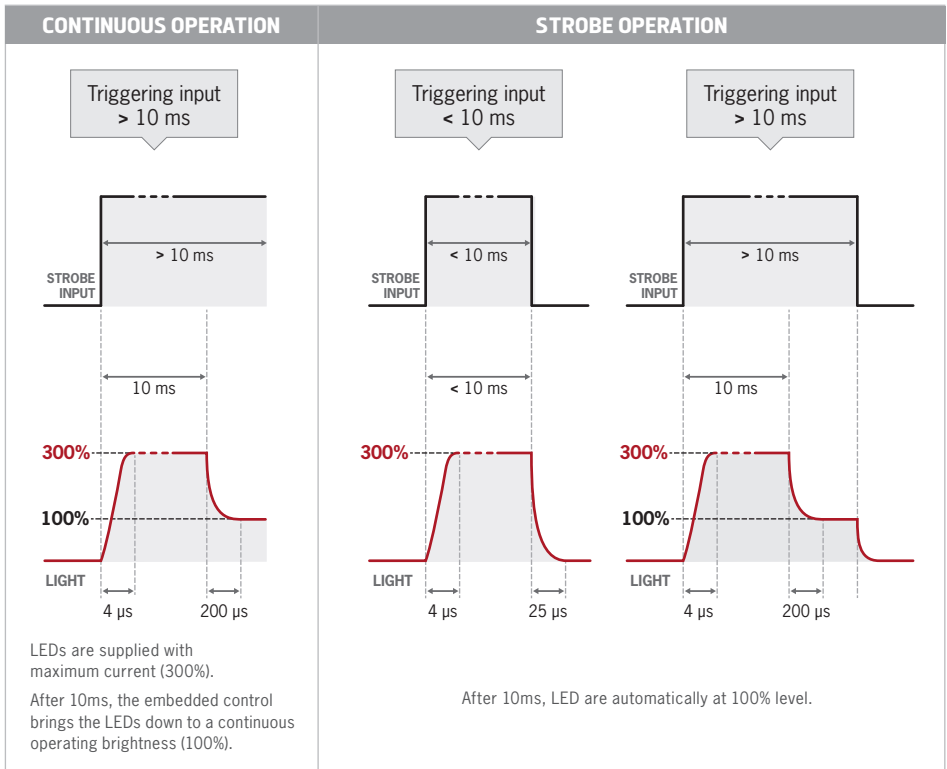



■ DIMMING 0-10V ON PIN 5

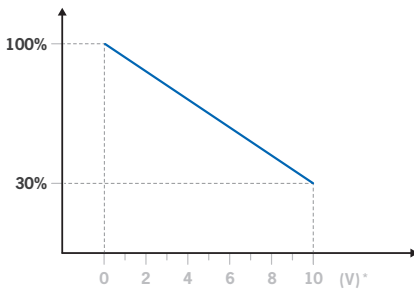

CONTINUOUS WORKING

Dimming during continuous working (CW) operation

* Voltage applied to PIN 5.

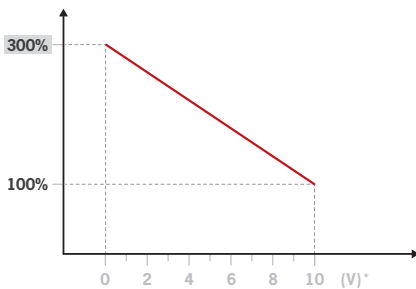

STROBE OVERDRIVE ≤10ms ON TIME

Dimming during strobe mode
≤10ms maximum on time

* Voltage applied to PIN 5.

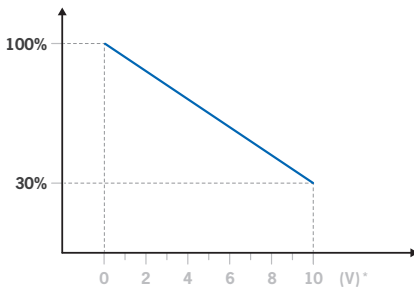

STROBE >10ms ON TIME

Dimming during strobe mode after LEDs are ON for more than 10ms

* Voltage applied to PIN 5.



■ ADDITIONAL ACCESSORIES

Polariser



Secure the polarizer attachment in place using the two supplied M2 screws

Ref: TPL-POL-Z-SPOT**

** Not for use with UV 405nm, 385nm and 365nm options.

Mounting Accessory

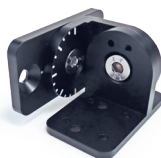

Ref: SWIVEL-MOUNT-T***

*** Requires TPL-MOUNT-Z-SPOT or TPL-MOUNT-M30 for compatibility.

Mounting Plate

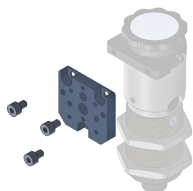

M4 screws supplied, to securely attach the mounting plate to the body of the Z-SPOT.

Ref: TPL-MOUNT-Z-SPOT

Extra M30 Nuts



Ref: TPL-NUT-M30

ALSO AVAILABLE:

Mounting Accessory



Ref: TPL-MOUNT-M30

Mounting Accessory



Ref: TPL-MOUNT-M30-ROD

M12 5 pins cables



2 meters: C-M12-5P-2M

5 meters: C-M12-5P-5M

10 meters: C-M12-5P-10M



ZOOM Z-SPOT TECHNICAL USER GUIDE

P8/8

■ USER SAFETY

Do not modify or dismantle all or part of the product.

Respect the power supply voltages and the connection terminals.

Ensure power supply is switched off whilst connecting product and turn on only once product is fully connected. Failure to do this may damage the product and invalidate the Warranty

Do not stare at the lighting source directly.

Follow advice below for installation to minimise operator exposure to the light source.



INSTALLATION GUIDANCE:

- Forbid or limit the direct access to the lighting source (exposure into the radiation axis).
- Establish a security perimeter to prevent the operators from approaching the lighting source beyond the recommendations of the manufacturer.
- If the workstation permits it, introduce a filter that will stop the lighting radiation under a fixed or adjustable frame between the source and the operator. When these measures cannot be implemented, supply the operators with glasses (class 4) available from TPL Vision.

It is the responsibility of the persons installing this product to ensure that all means possible (such as those stated above) have been implemented to reduce exposure of the machine operators to the light emitted from this product.

WARNING

**HOT SURFACE
DO NOT TOUCH**

High ambient temperatures and insufficient heat dissipation can lead to hot housing surfaces. Do not touch the light during operation. Keep a minimum distance of 20 mm between the light and thermally insulating surfaces or mount the light on a thermally conductive surface.

■ EQUIPMENT MAINTENANCE

CLEANING (when the product is switched off)

Please use a soft and dry cloth. Do not use any abrasive material. Do not use any cleaning solvent or aggressive chemical product. TPL Vision recommends to use isopropyl alcohol.

■ OPERATING CONDITIONS

-10° to +40°C (14° to +104°F) / 80% of humidity without condensation.

No thermal shock (max temperature variation: 10°C (18°F) in 24h). Not for outdoor use.



Brenchley House, School Road
Charing, Kent TN27 0JW
United Kingdom

TPL VISION
IS AN **ISO 9001**
CERTIFIED MANUFACTURER

+44 (0)1738 310 392

contact@tpl-vision.co.uk

www.tpl-vision.com